

## APPENDIX 11: HARRIS MATRIX

# Overview of Harris Matrix

Phase 4B

Phase 4

Phase 3

Phase 2

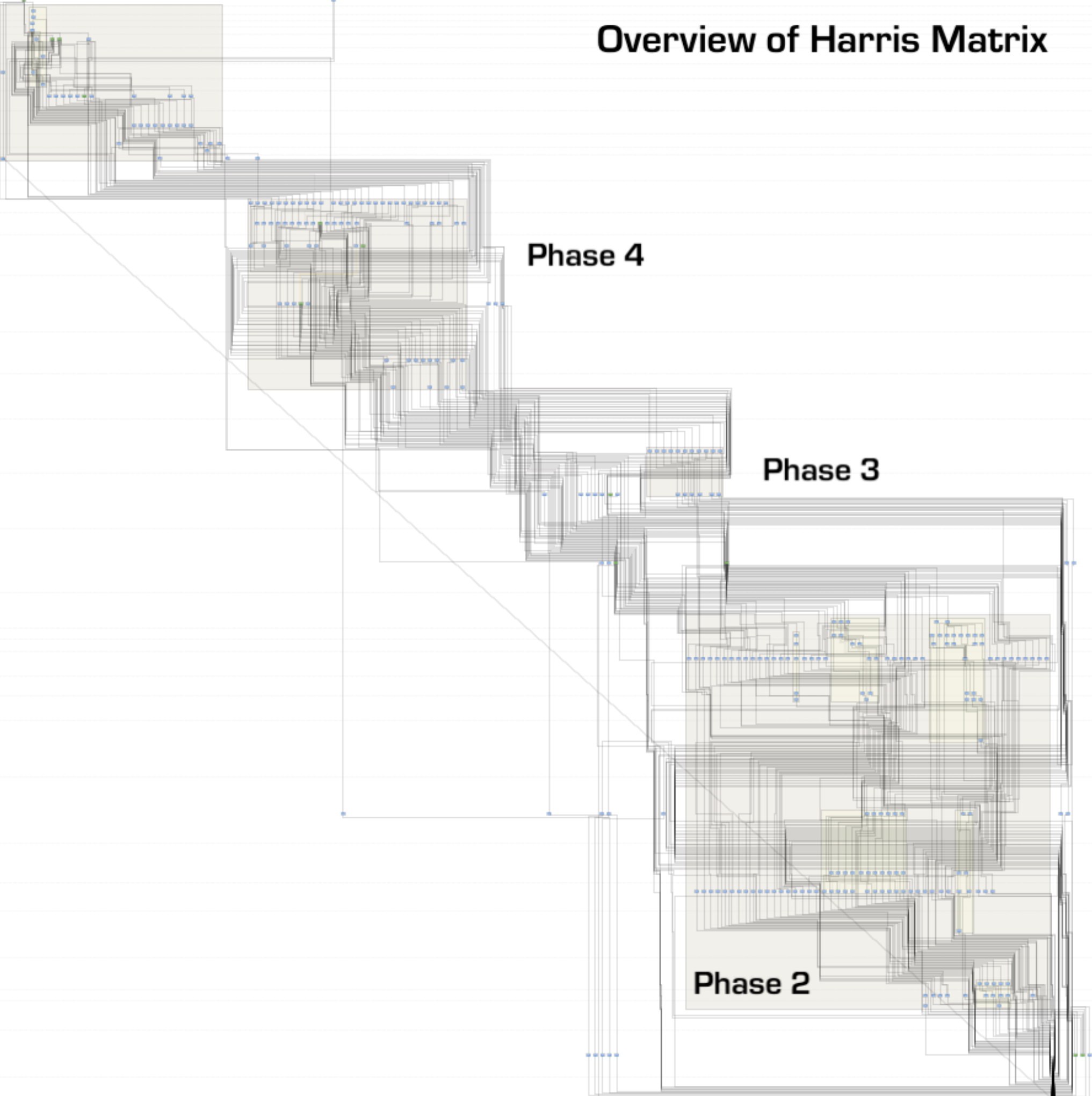

# Overview of Phase 4B Harris Matrix

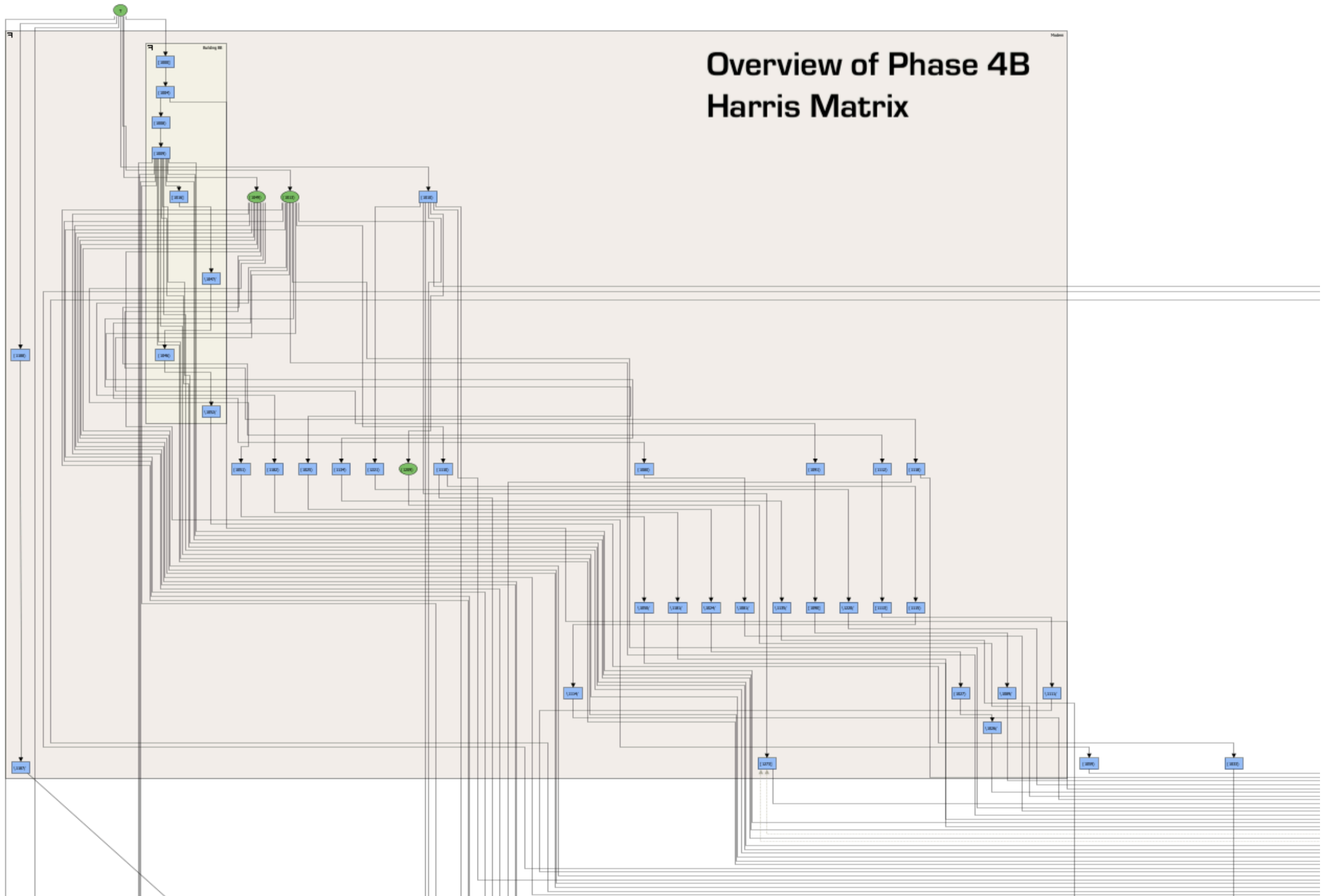

# Phase 4B part 1 of 4

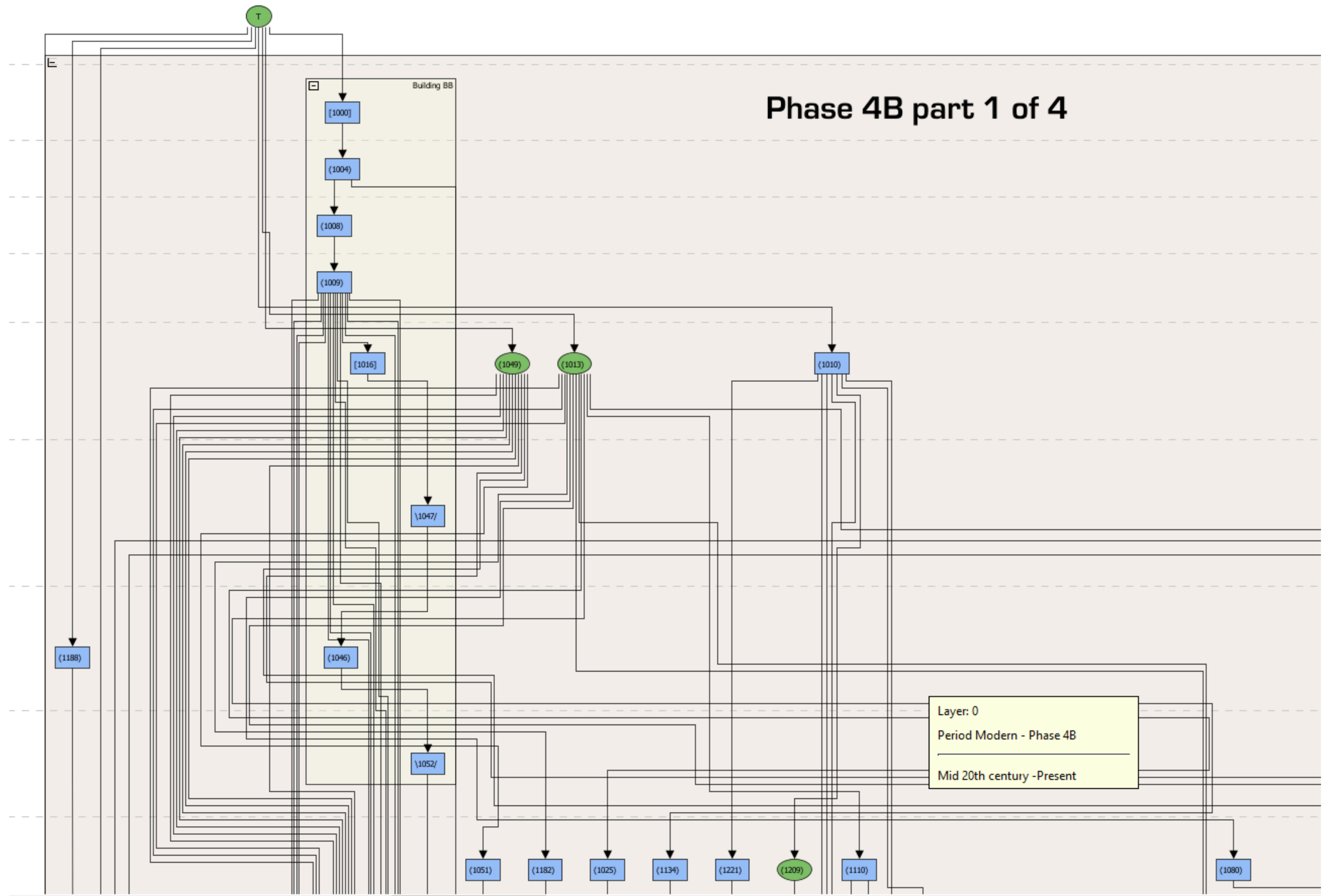

# Phase 4B part 2 of 4

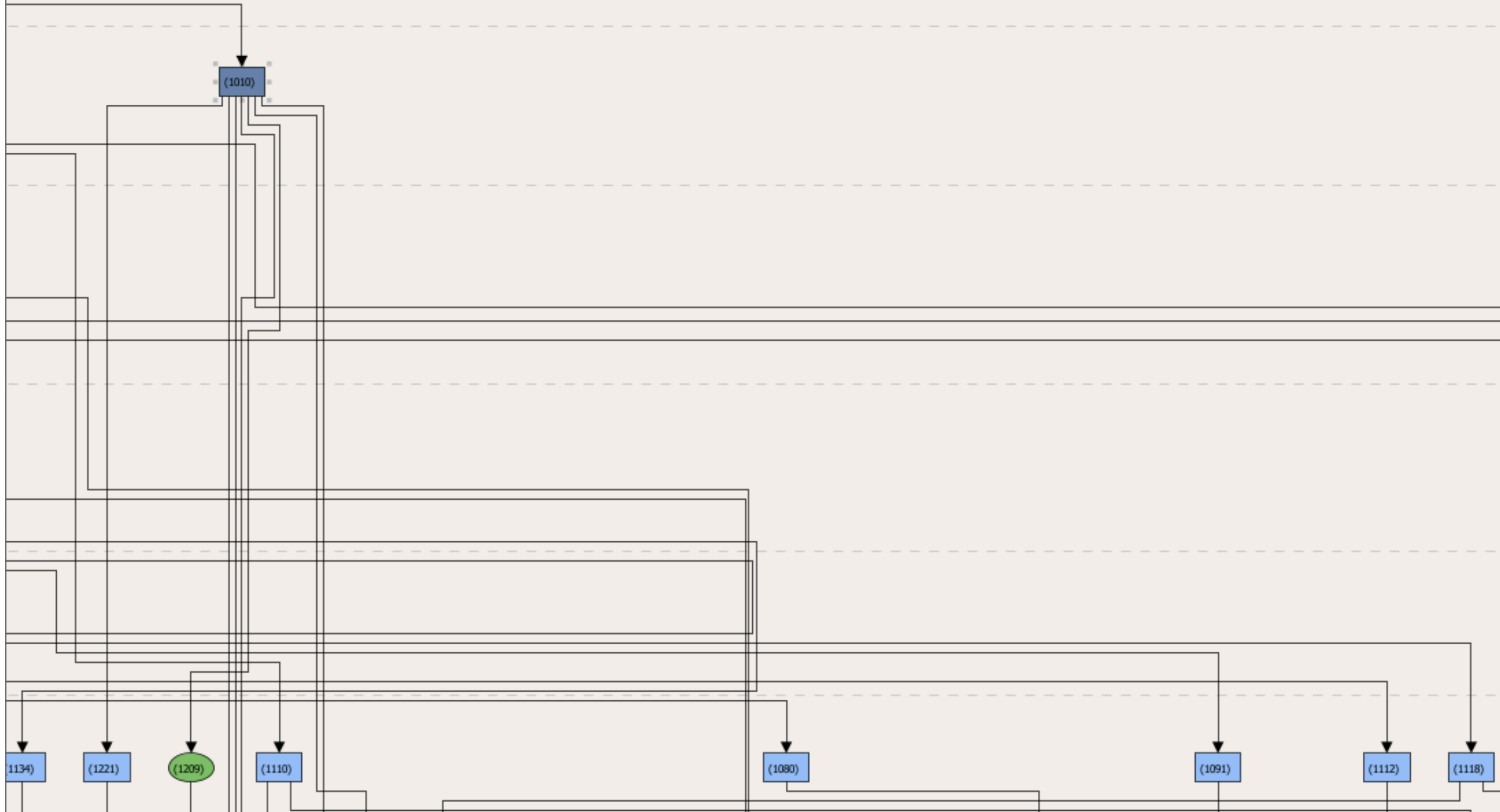

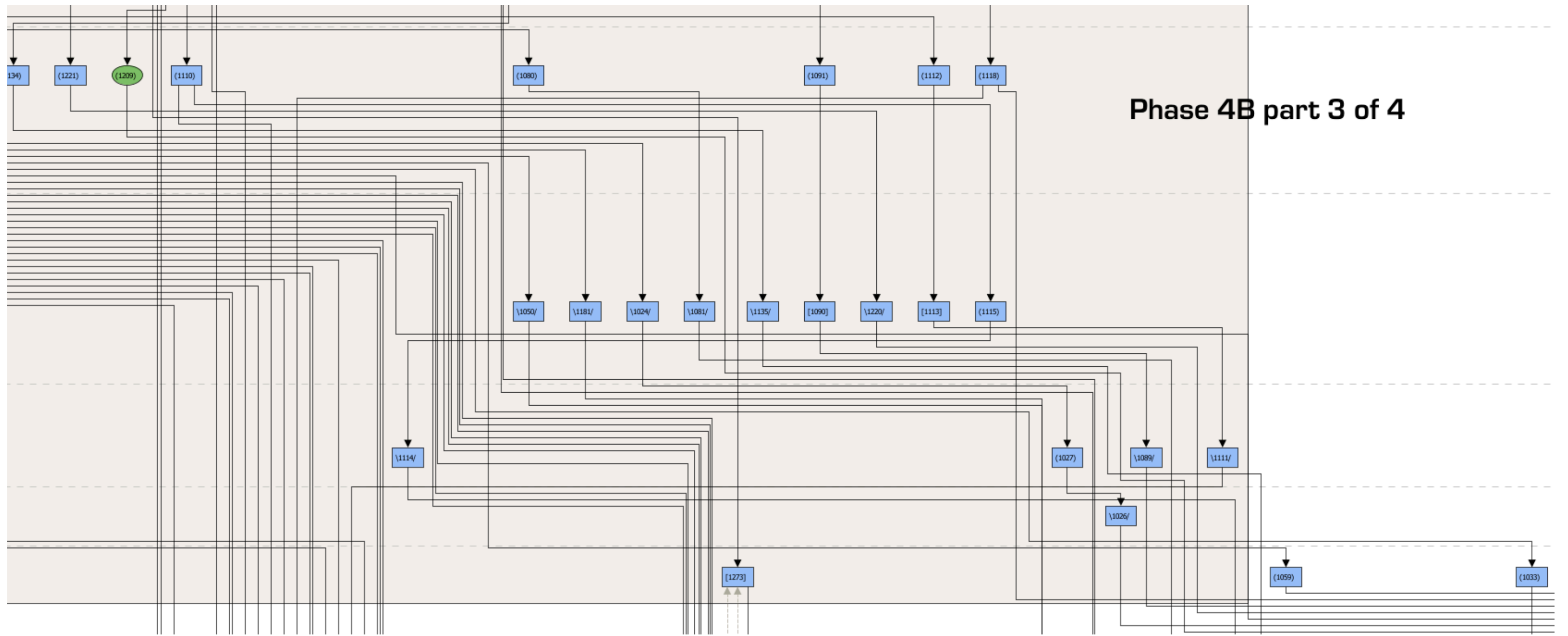

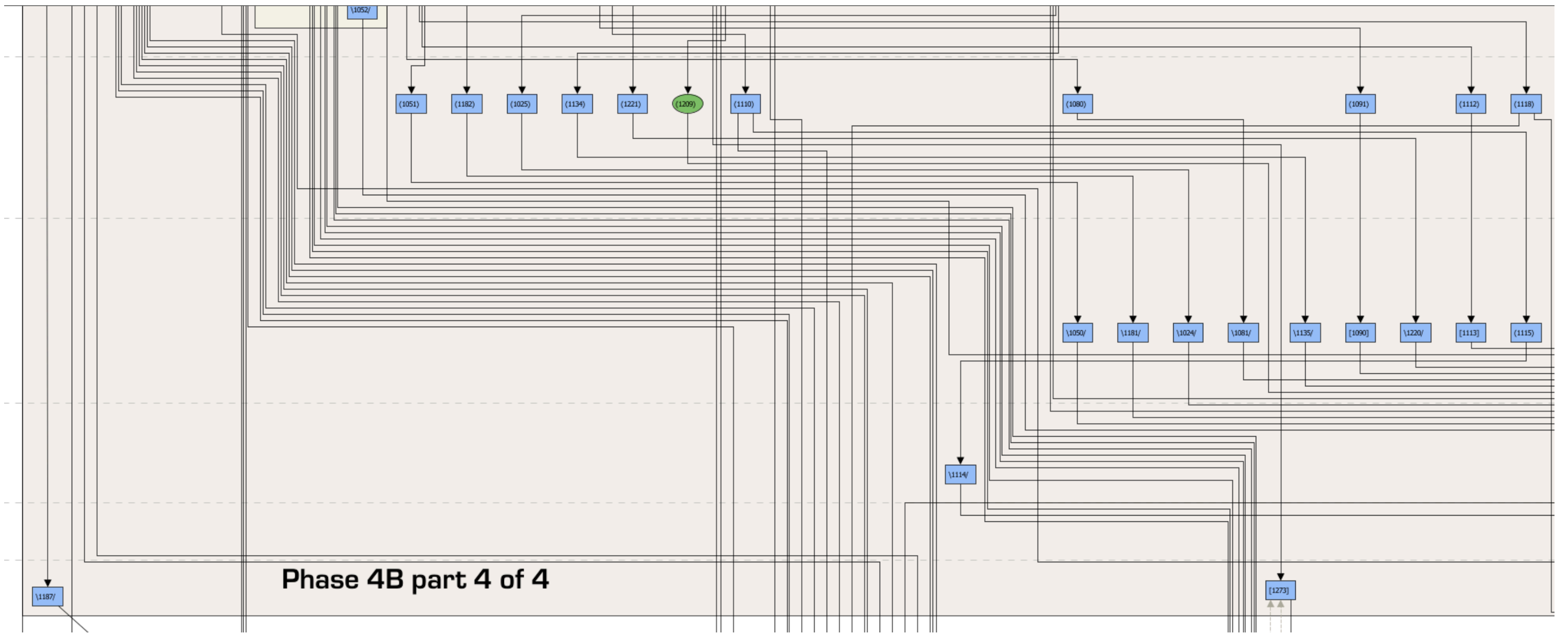

log file mcs display

Early School

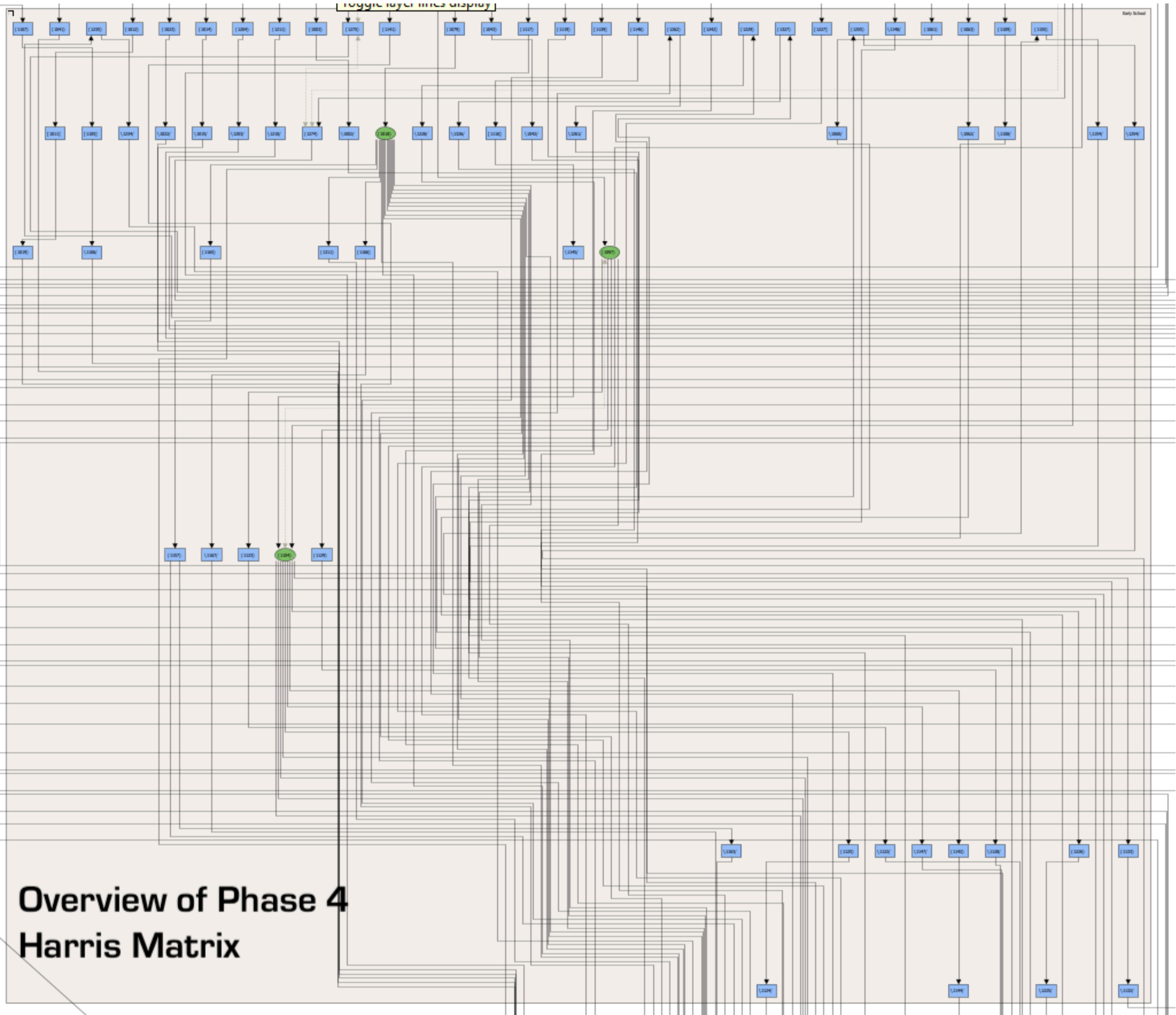

# Overview of Phase 4 Harris Matrix



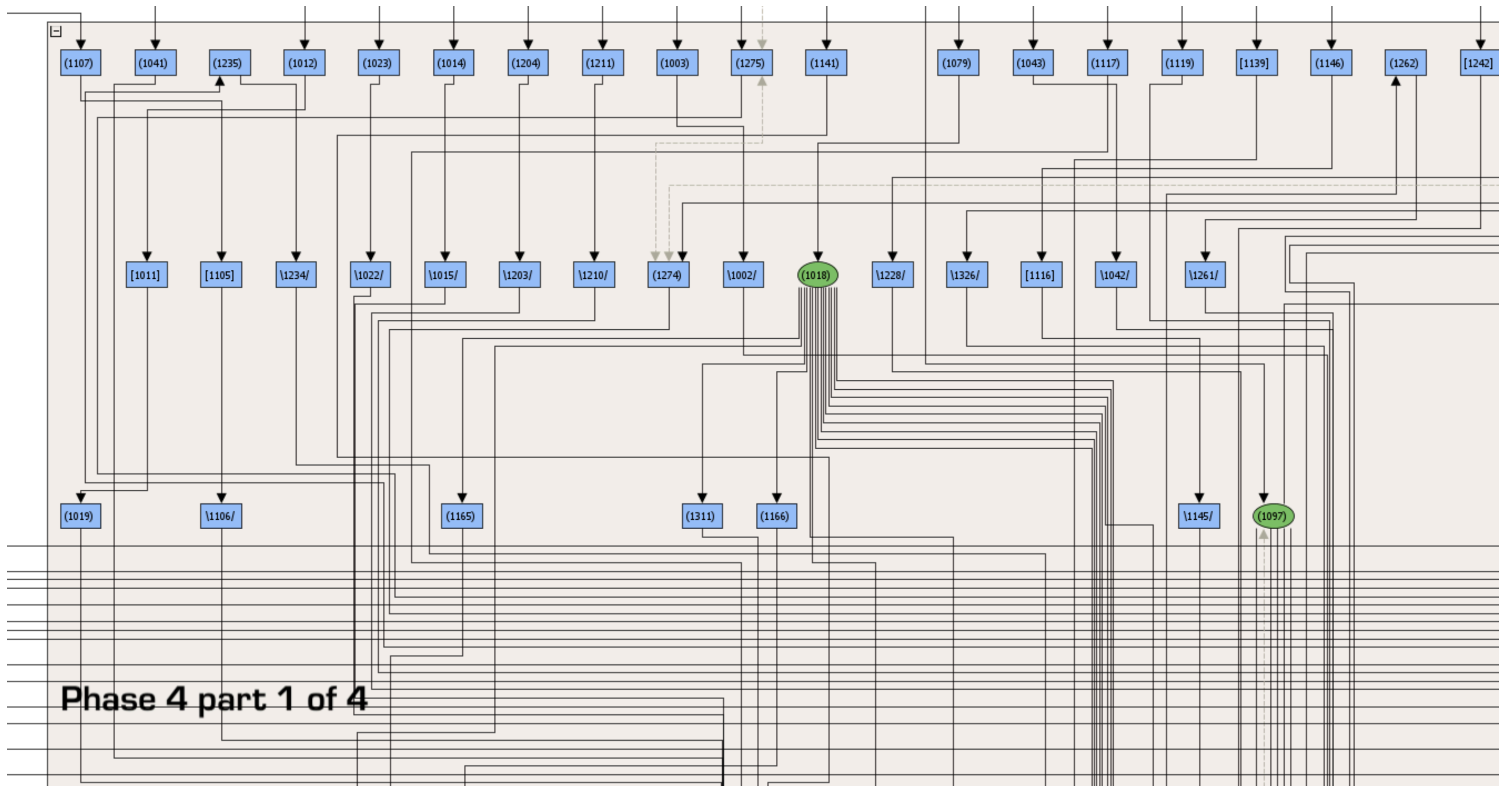

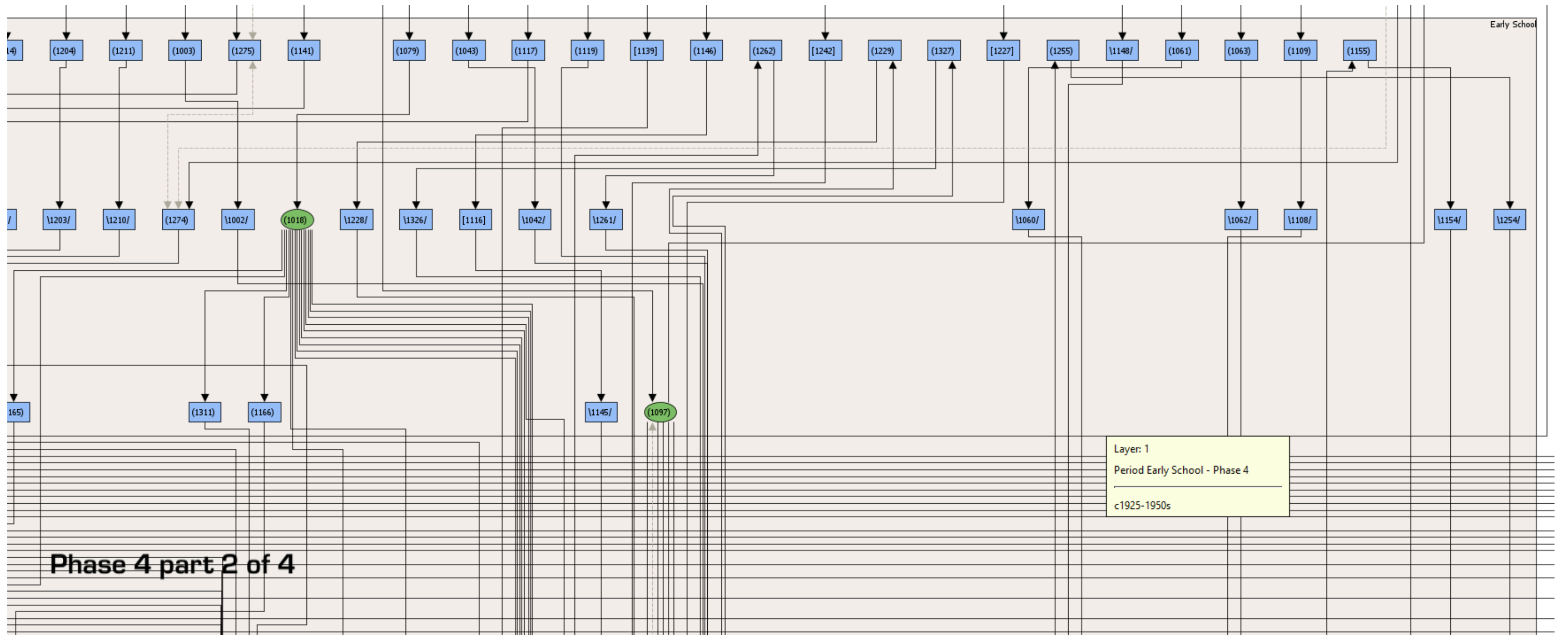

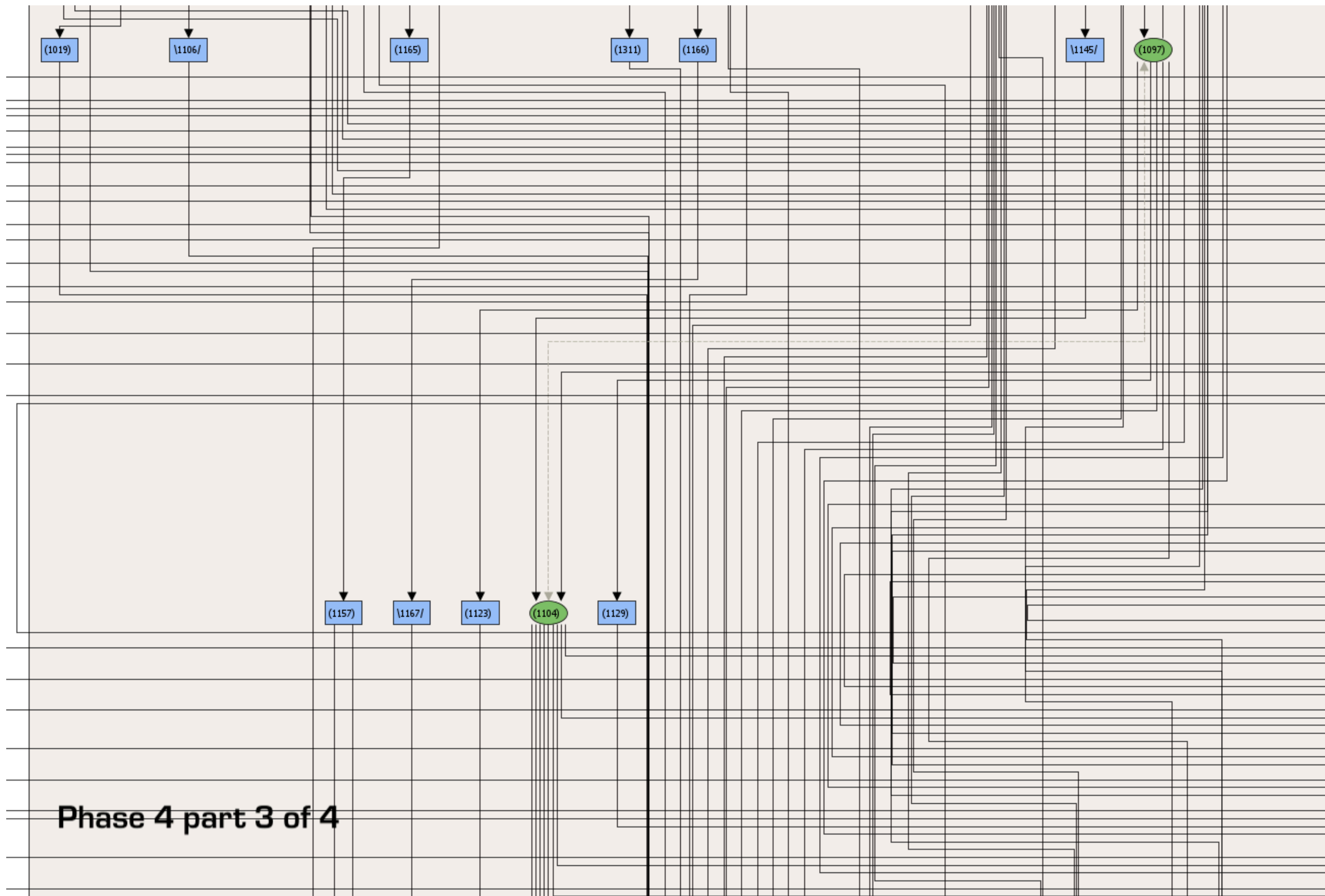

**Phase 4 part 3 of 4**

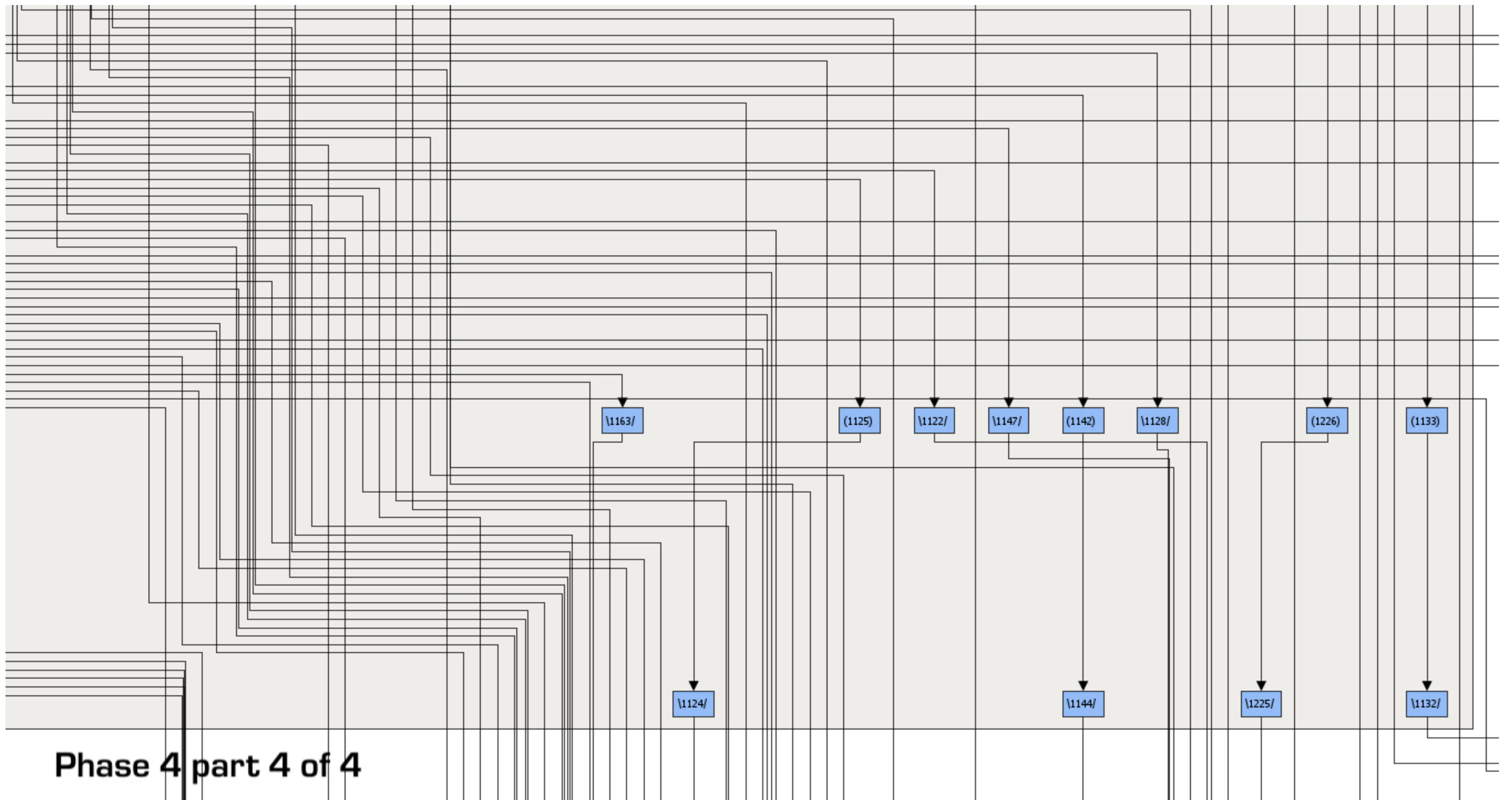

Phase 4 part 4 of 4

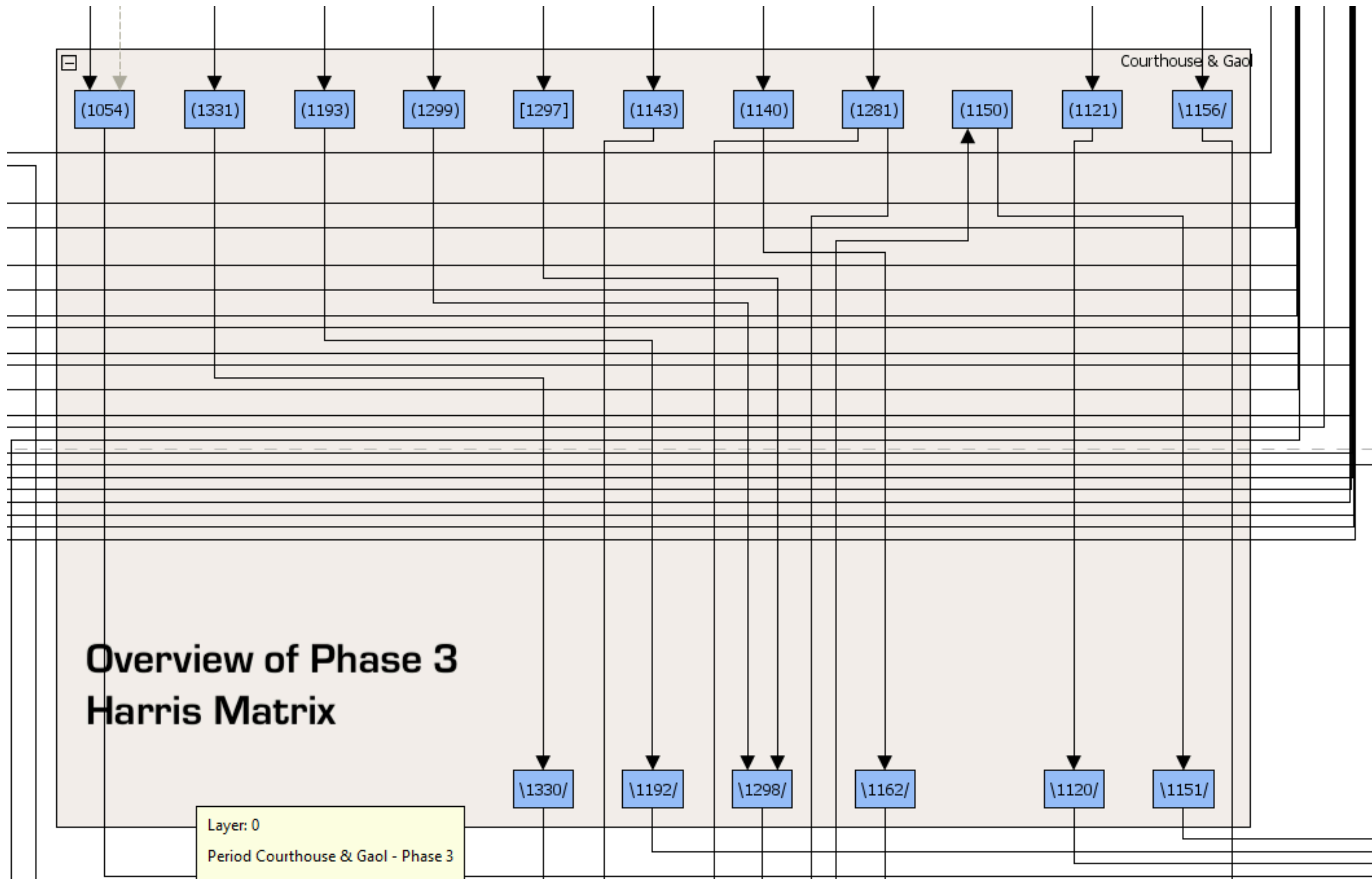

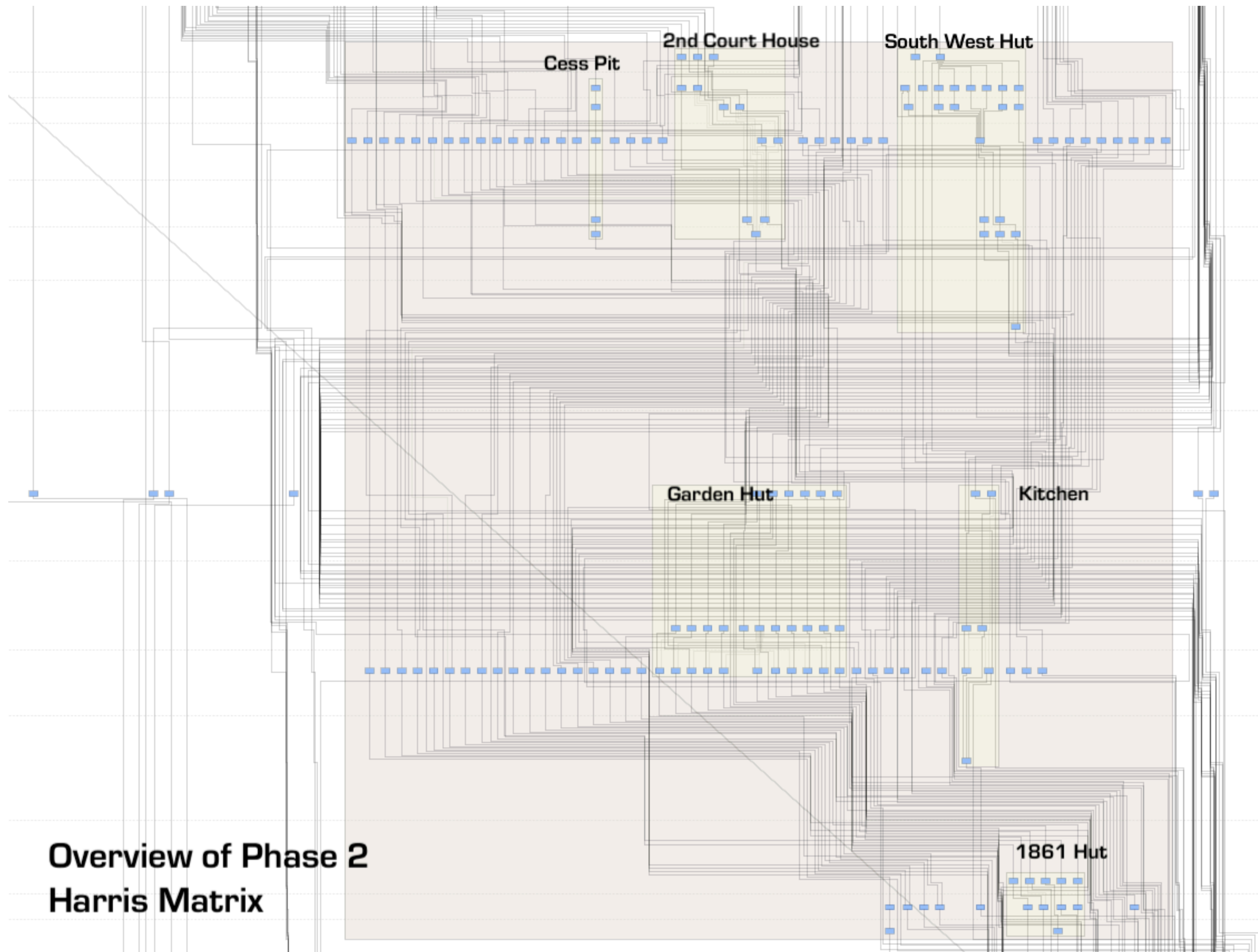

**Overview of Phase 2  
Harris Matrix**

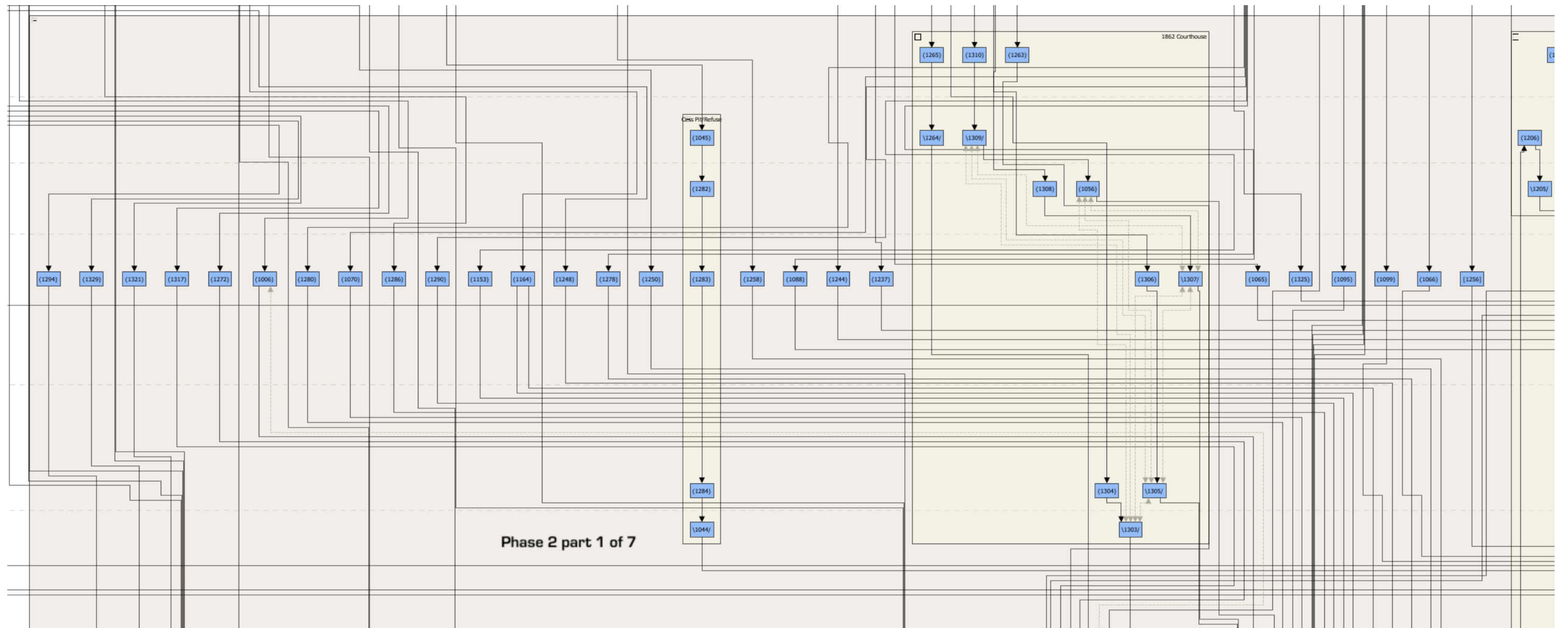

1862 Courthouse

Southwest Hut

# Phase 2 part 2 of 7

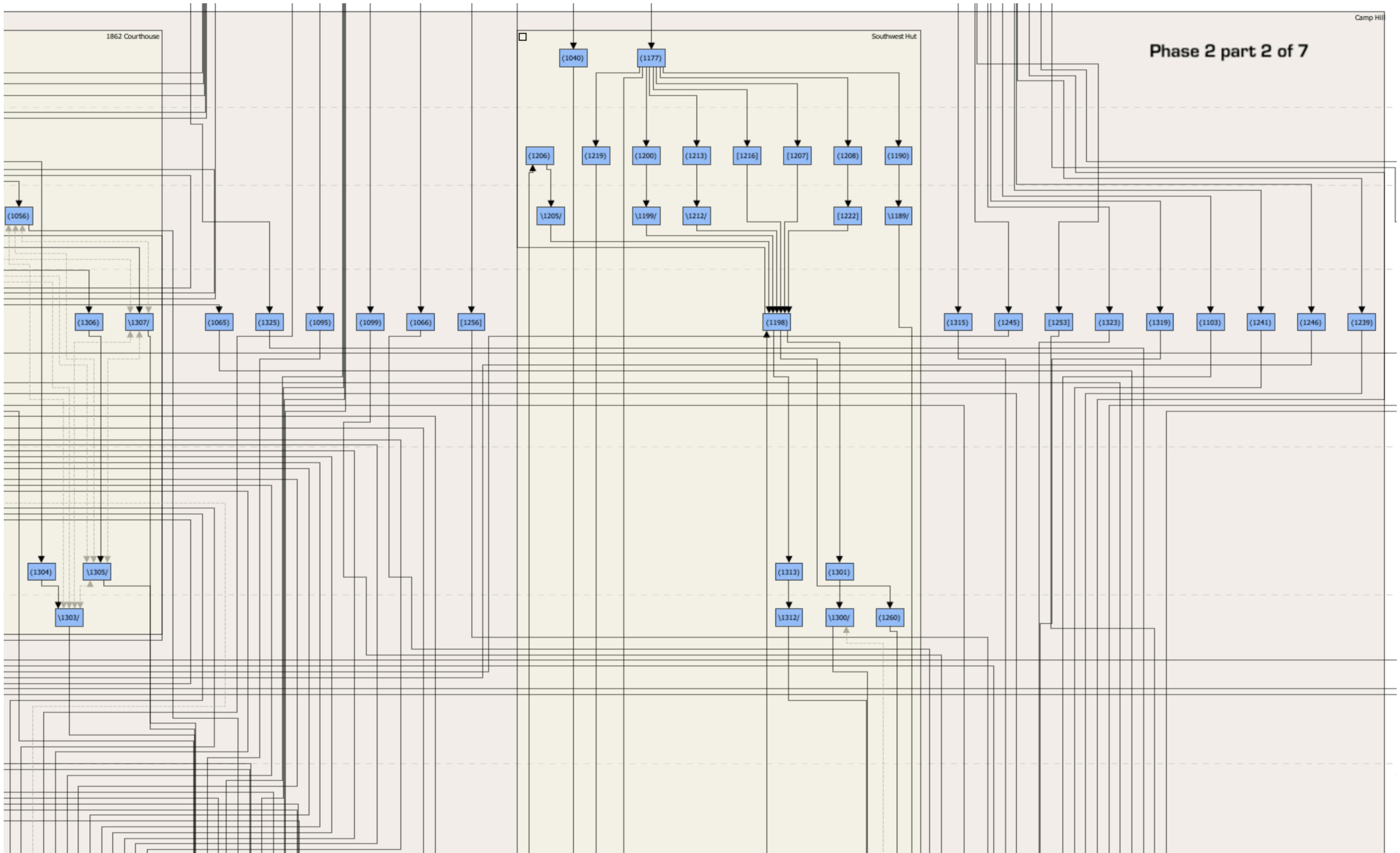



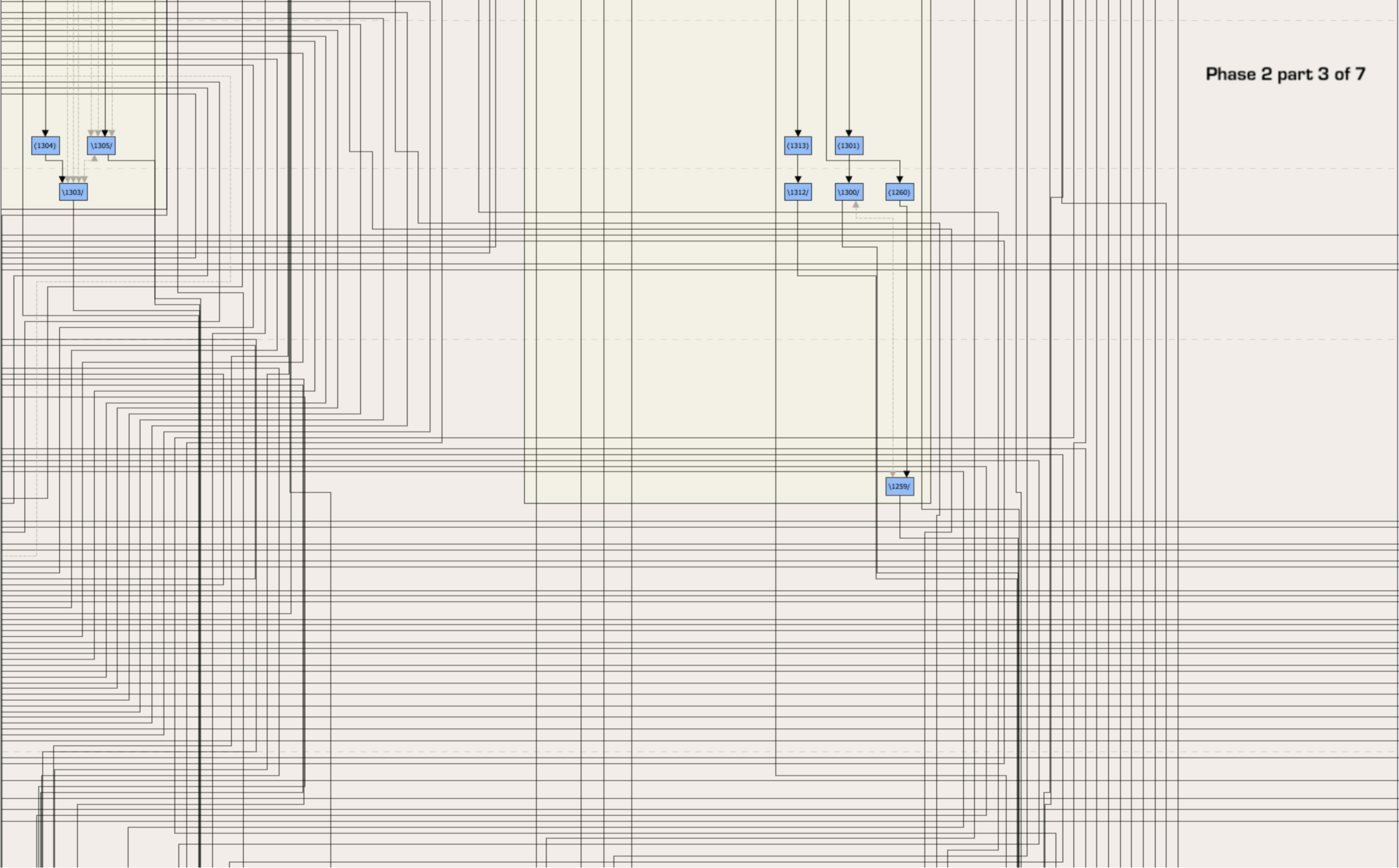

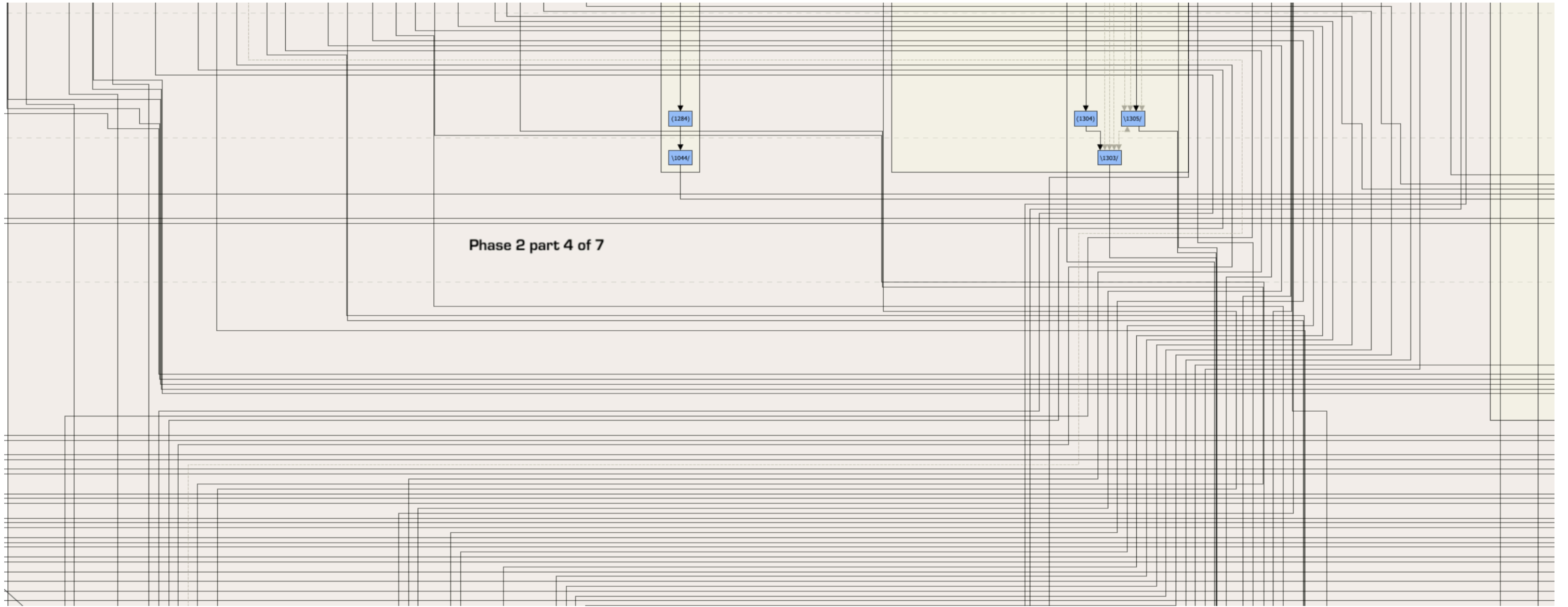

Phase 2 part 5 of 7

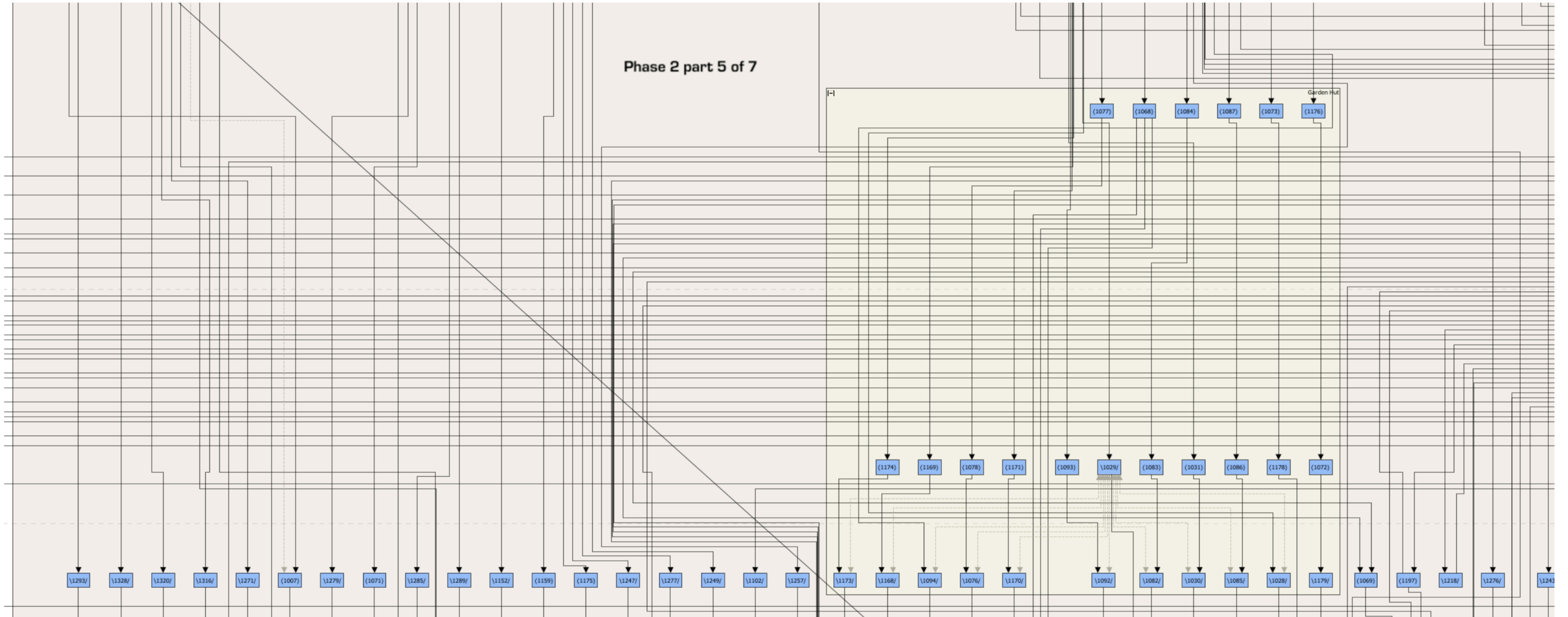

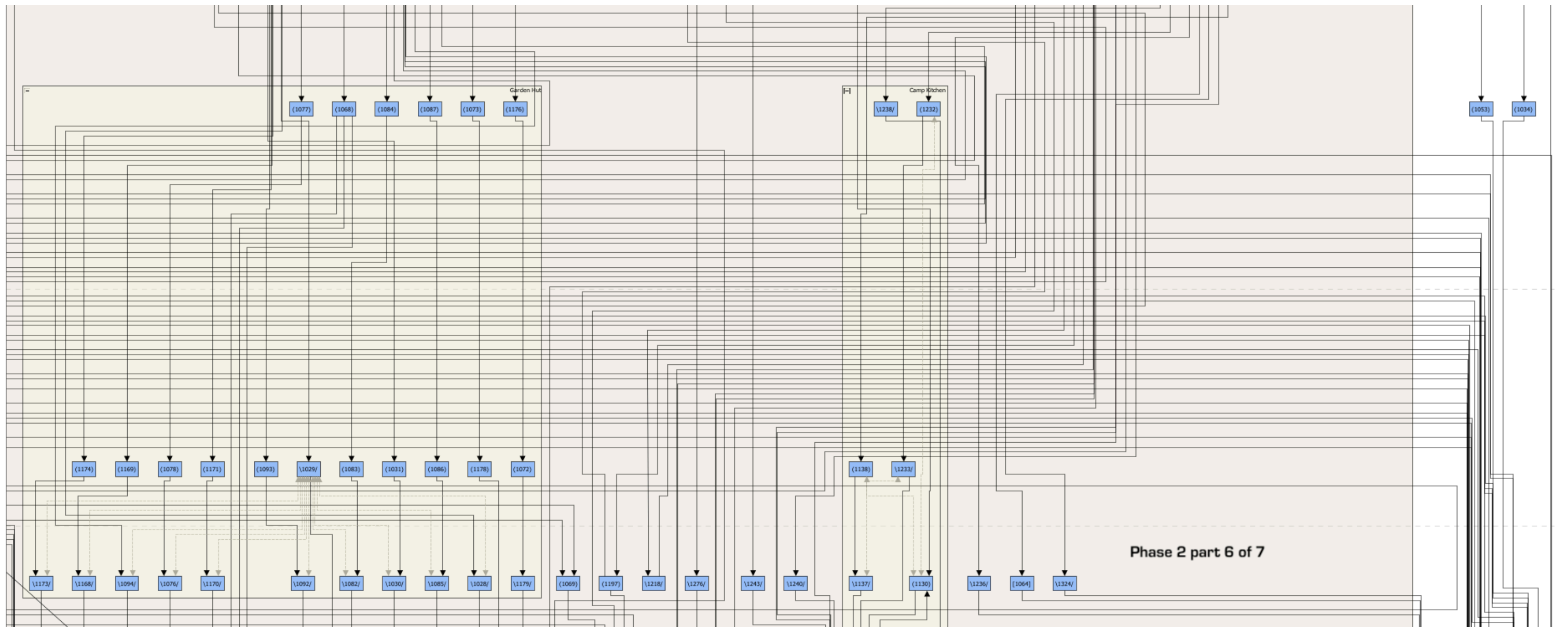

Phase 2 part 7 of 7

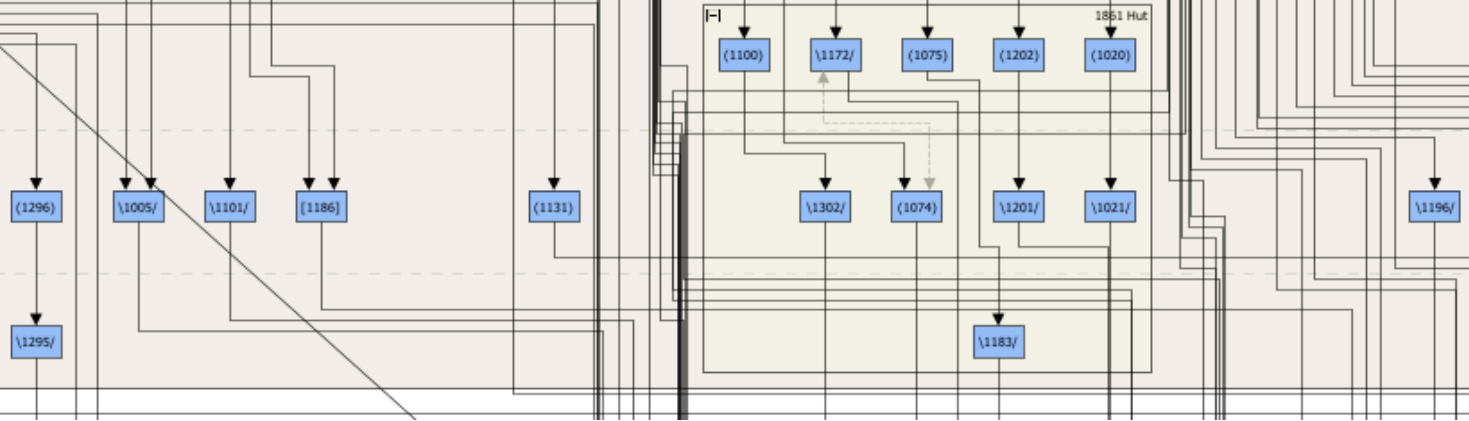

Cess Pit/Refuse

(1045)

(1282)

(1248)

(1278)

(1250)

(1283)

(1258)

(1088)

**Cess Pit  
Harris Marix**

(1284)

(1044)

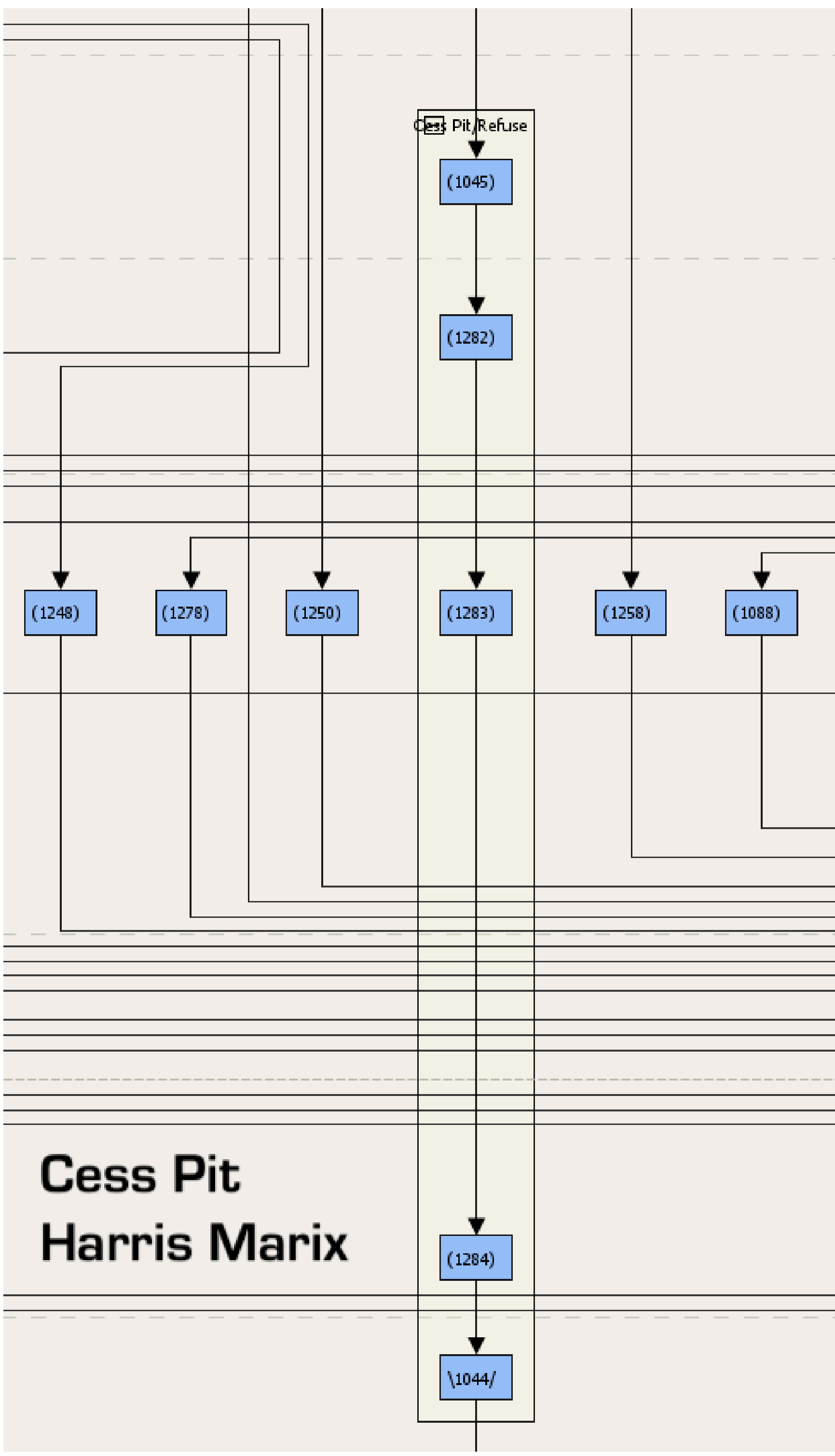

# South West Hut Harris Matrix 1

Southwest Hut

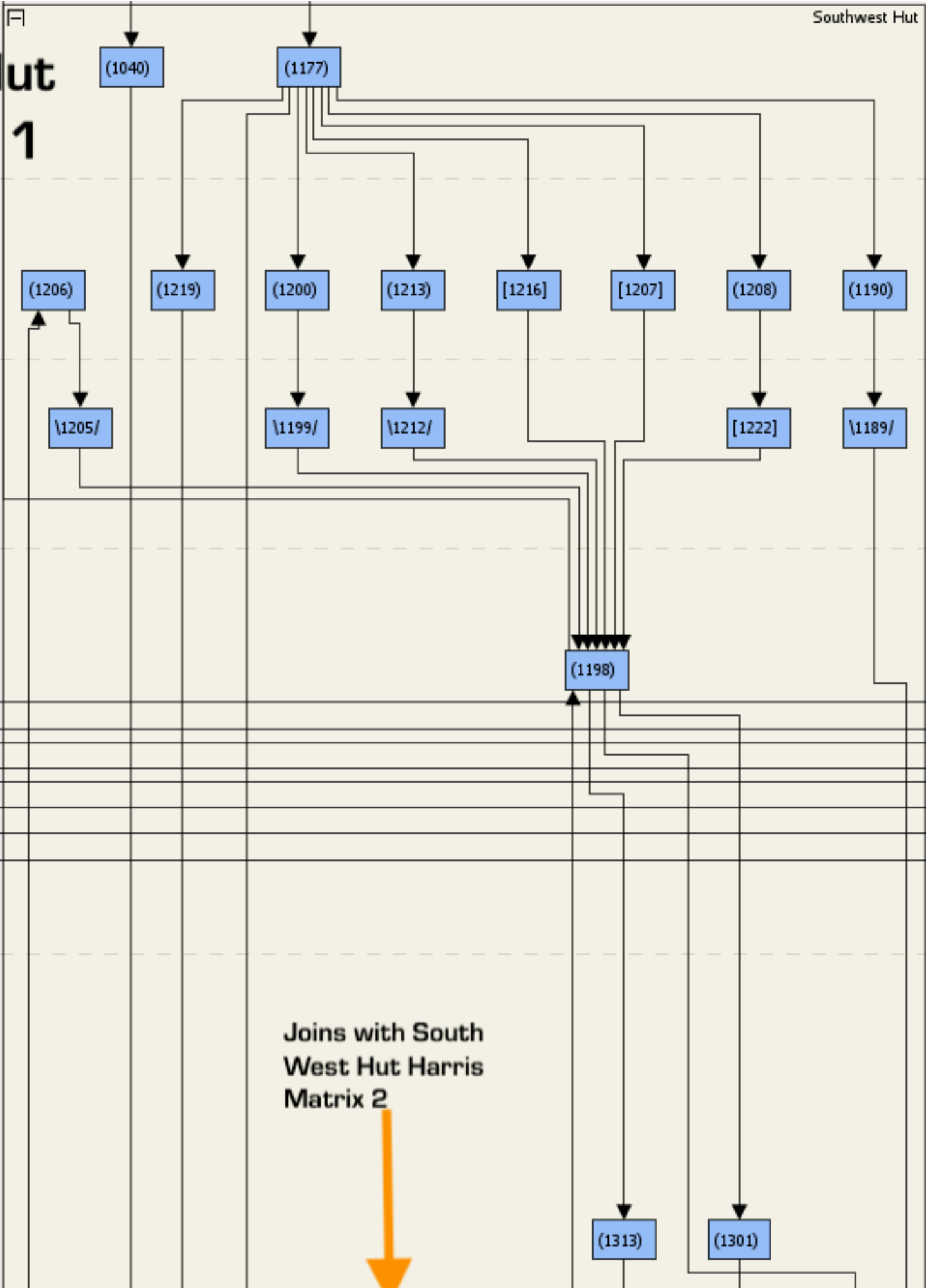

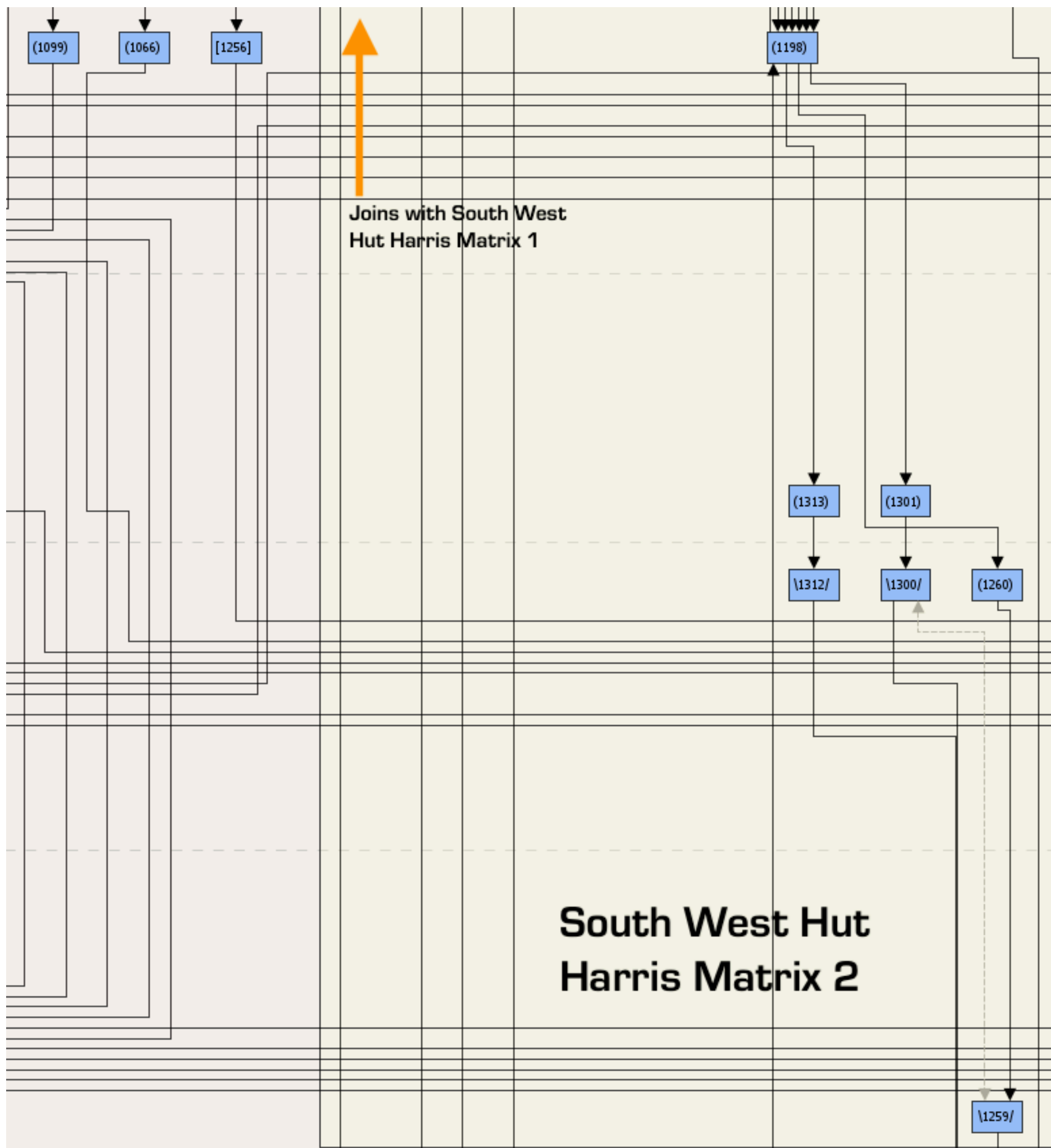



# Camp Kitchen Harris Matrix 1

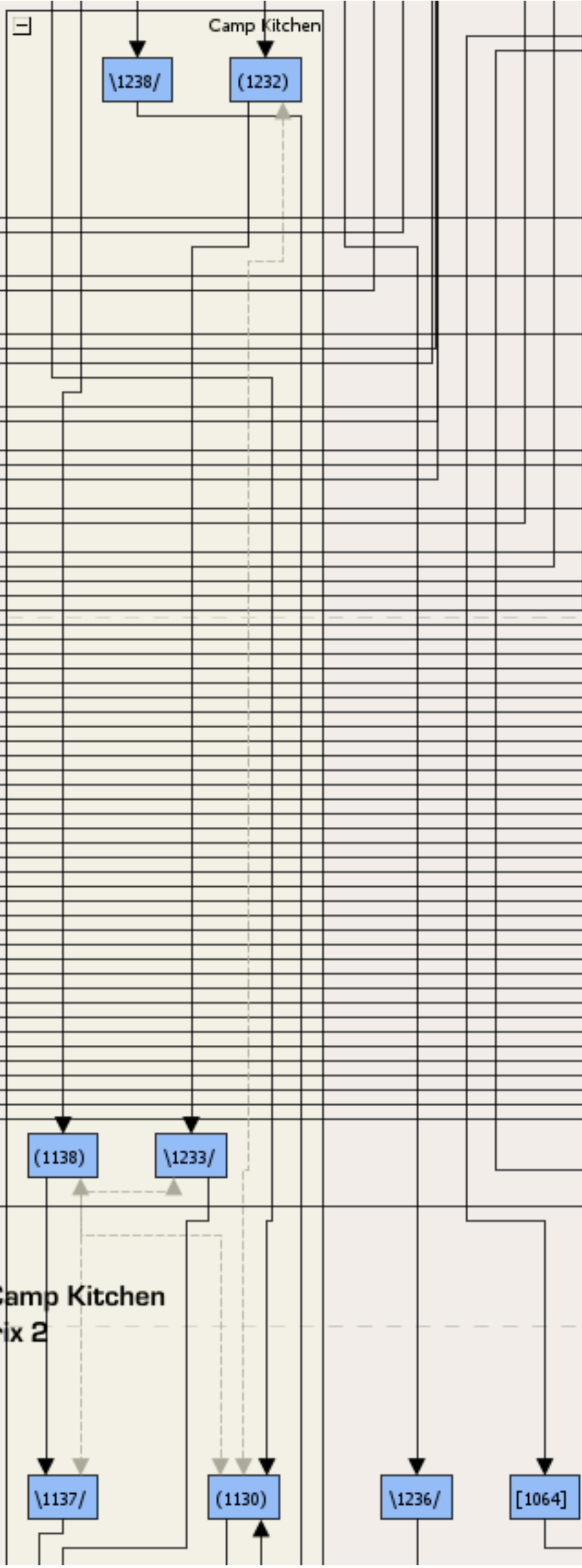

Joins with Camp Kitchen  
Harris Matrix 2

Camp Kitchen

\1238/

(1232)

(1138)

\1233/

\1276/

\1243/

\1240/

\1137/

(1130)

\1236/

[1064]

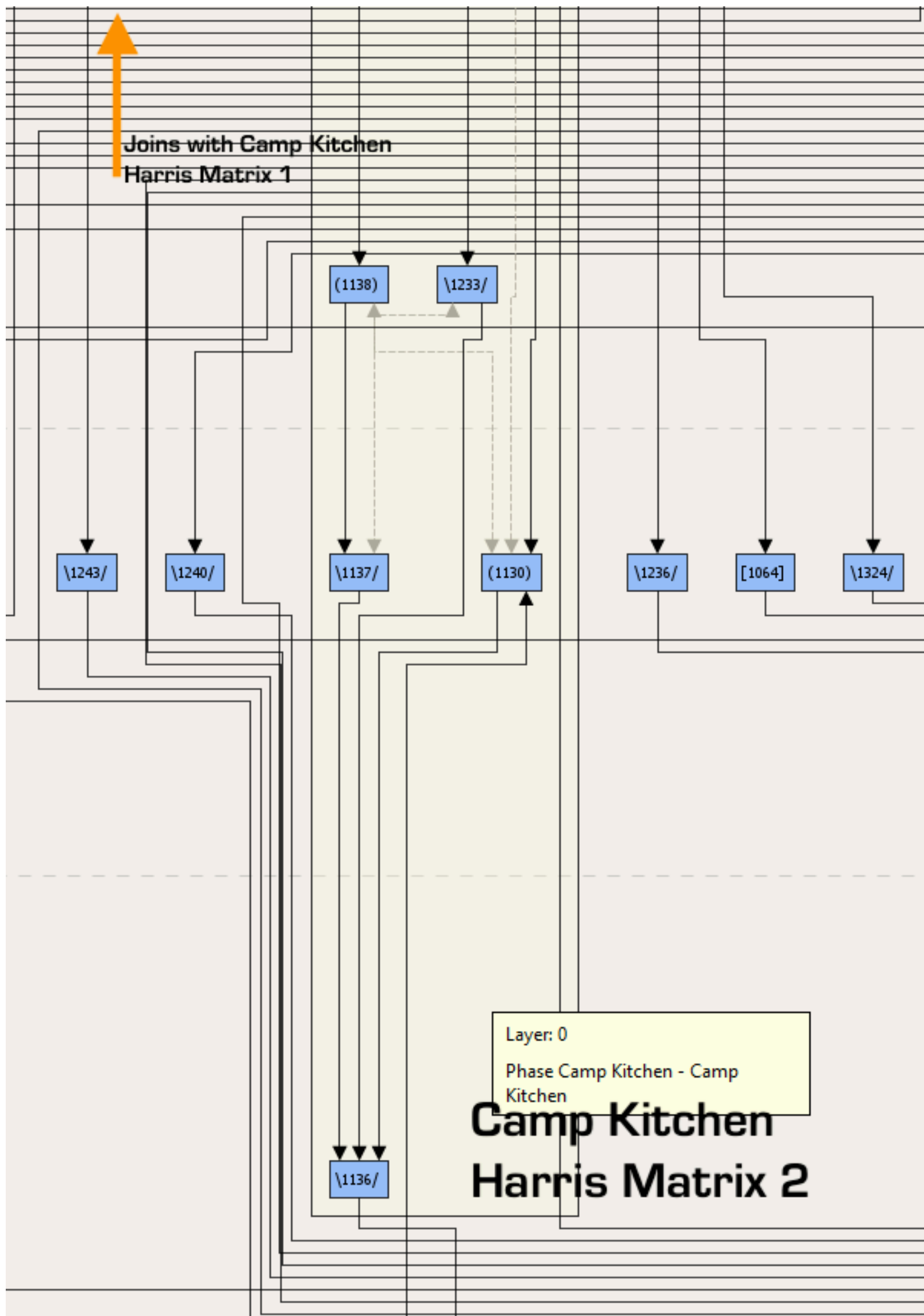

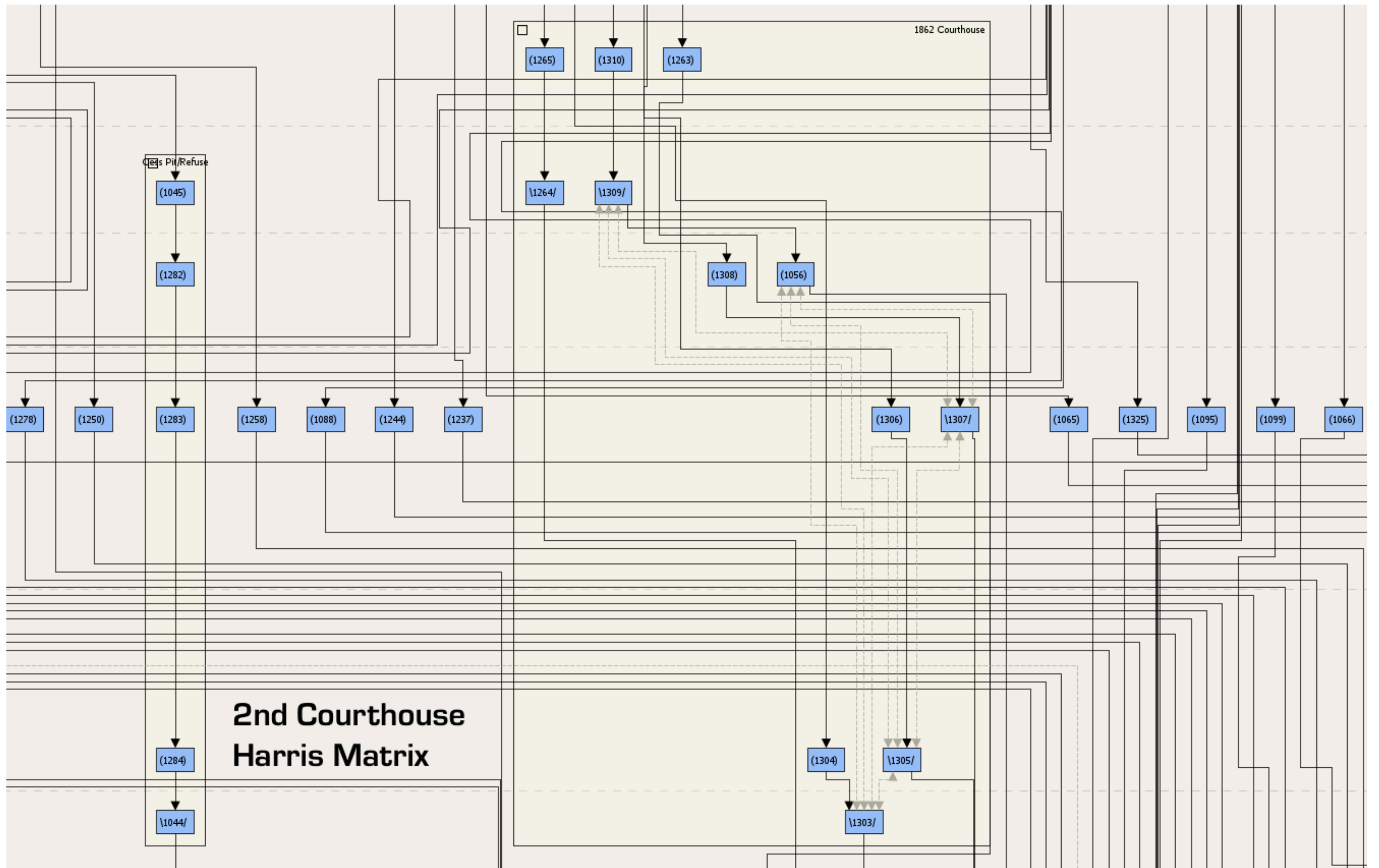

# Garden Hut Harris Matrix

